

User's Manual

NOCPIX  
**ACE H50R**

Thermal Imaging Scope



 **Nocpix**

# WARNING! ITAR REQUIREMENTS

These products may be subject to export and foreign trade control laws of the United States and may not be exported without prior approval of the U.S. Department of State. Learn more at [irayusa.com/ITAR](http://irayusa.com/ITAR).

## CAUTION

Use of controls or adjustments or performance of procedures other than those specified herein may result in hazardous radiation exposure.

2601 State Hwy 121, Building 3, Suite 306, Lewisville, TX 75056  
800.769.7125 [info@irayusa.com](mailto:info@irayusa.com)

**NOTICE:** This product is a Class 3R laser product.

**Explanatory Label**



**Mfr ID and Certification Label**

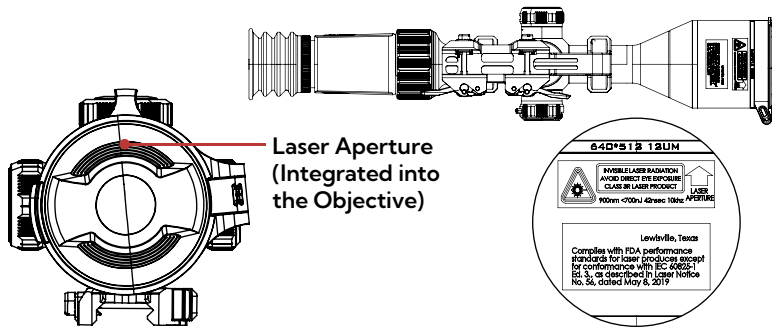

**Laser Aperture  
(Integrated into  
the Objective)**

**NOTE:** There is no scheduled maintenance or service necessary to keep this product in compliance and no user service or maintenance is required.

This Laser Product is designated as Class 3R during all procedures of operation.

Wavelength: 900nm  
Laser Power for Classification: <700nJ  
Emission Type: Pulsed, Invisible  
Pulse Width: 42 nSec  
Emission Frequency 10kHz

**INVISIBLE LASER RADIATION  
AVOID DIRECT EYE EXPOSURE  
CLASS 3R LASER PRODUCT**

### NOTES:

- There is no service required or allowed of this product by the end user.
- This product is to be serviced or repaired only by factory authorized technicians.
- This product is not to be opened or modified by the user.
- The user is not to modify the unit or remove protective covers or housing. Service is only to be handled by authorized factory trained technicians. This product has no user-serviceable parts.
- Do not point laser or allow laser light to be directed or reflected toward other people or reflective objects.
- Operators should be trained to not target the eyes of people, animals, and pets or aim at reflective objects, etc.
- There is a potential hazard of eye or skin exposure to laser radiation if the included instructions are not followed.
- This laser is never to be operated if the unit is defective or the cover or seal is damaged.
- Always operate the product with the aperture pointed downrange.

## Table of Contents

1. Overview .....	2
2. Features .....	2
3. Tech Specs .....	3
4. Accessories .....	4
5. Components and Controls .....	5
6. Description of Control Buttons & Shortcuts..	6
7. Quick Start Guide.....	8
8. Charging the Built-in Battery Pack .....	9
9. Installing an 18650 Battery .....	11
10. Battery Status Indicators .....	12
11. Switching the Battery Power Supply .....	13
12. Battery Safety Warnings .....	14
13. External Power Supply .....	14
14. Operating Instructions .....	15
15. Zeroing the ACE H50R.....	21
16. Non-Uniformity Correction.....	22
17. Photography and Video Recording .....	23
18. Accessing the Internal Memory .....	25
19. Using The NOCPIX App.....	26
20. Integrated Laser Rangefinder .....	27
21. Digital Zoom .....	28
22. Ultra-Clear Mode .....	28
23. Main Menu Options and Descriptions .....	29
24. Basic Inspection .....	51
25. Basic Maintenance.....	51
26. Warranty .....	52
27. FCC Statement .....	53
28. General Troubleshooting .....	53
29. Notes .....	56

### WARNING: CHOKING HAZARD

Children under 3 years old can choke or suffocate on small parts of this product. This product is not a toy; keep out of reach of children.

# 1. Overview

The ACE Series of thermal scopes combines unique features and a familiar form factor to give users the perfect night hunting optic. With a lens-integrated laser rangefinder the ACE maintains a sleek aesthetic and improved long-range capabilities. Other features include an ocular 1-3x magnifier, 2560x2560 display, 30mm tube-style housing, 60hz refresh rate, and Reality+ image processing. The internal battery combined with an 18650 battery provide up to 7 hours of run time so you can stay in the field longer. The integrated LRF paired with built-in ballistics software gives you more confidence to take shots at extended distances with ease, while the Gallery function allows for instant replay of your recordings.

# 2. Features

- 12 µm high-performance thermal detector
- ≤15 mK sensitivity
- 1300-yard laser rangefinder integrated into the objective lens
- Stepped digital zoom from 3x–24x
- Ocular magnification from 1–3x
- T-6063 Aluminum housing
- Dual power supply solution for extended operation
- Maximum detection range: 2850 yards
- 2560x2560 AMOLED display
- High frame frequency: 60Hz
- Recoil activated video
- Five ballistics profiles and a user-defined, multi-variable ballistics calculator
- Multiple zero profiles and ranges
- Traditional 30 mm diameter housing design
- Built-in 64 GB storage to support image capture and video recording
- Built-in Wi-Fi module
- Mobile device App compatible
- Gallery function for photo/video playback
- Picture in Picture (PIP)
- User-friendly interface
- Ultra-clear mode for advanced image detail
- Warm and cool image-hue options
- Pixel calibration function

# 3. Tech Specs

ACE	H50R
<b>Sensor</b>	
Resolution	640x512
Pixel Size	12 µm
Frame Rate	60hz
Sensor Sensitivity	≤15 mK
Image Processing	Reality+
Core	Nocpix 640
<b>Optics</b>	
Objective Lens	50 mm f/0.9
Magnification	3x
Digital Zoom	8x
Field of View	8.8° x 7.0°
Detection Range	2850 Yards
Display Type	1.03-inch Large-format AMOLED
Display Resolution	2560x2560
Color Palettes	White Hot, Black Hot, Red Hot, Color, Crimson, Viridian, Violet
P.I.P.	Yes
Rangefinder	Integrated 1,300 yd LRF
Eye Relief	50 mm
Diopter Range	-5 to +5
<b>Electronics</b>	
Onboard Recording	Video, Recoil-Activated Video, and Image
Onboard Storage	64 GB
Wireless Connectivity	Image and Video via App.
Data/Power Connector	USB-C
Power Supply	USB-C External, Built-In Battery Pack (3.5+ Hours), 18650 Batteries x2 (3.5+ Hours Each)
Start Up Time	<10 Seconds, Instant from Standby
<b>Physical</b>	
Size	14.37" x 3.54" x 2.68"
Weight	39.5 Oz
<b>Environmental/Warranty</b>	
Warranty	5 Years
Housing Material	T-6063 Aluminum
Ingress Protection	IP67
Operation Temperature	-4°F~122°F

## 4. Accessories

The ACE H50R thermal imaging rangefinder ships with everything you need to get out and hunt.

- 50mm Objective Lens Cap
- Standard Rubber Eyeguard
- 18650 Battery x2
- Battery Charger
- USB-C Cable for Data/Video
- Soft Case and Straps
- Lens Cloth
- User Manual



Various replacement accessories are available for purchase. Contact us at 800-769-7125 or [irayusa.com/support](https://www.irayusa.com/support).

## 5. Components and Controls

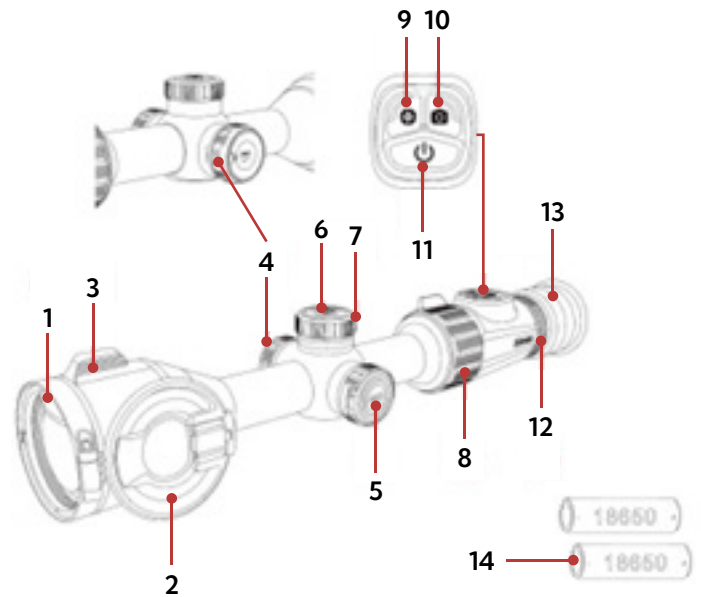

- 1 Integrated Laser Rangefinder
- 2 Objective Lens Cap
- 3 Objective Lens Focus Ring
- 4 USB-C Port / Cover
- 5 18650 Battery Compartment / Cover
- 6 Menu Button
- 7 Tactile Control Turret
- 8 Ocular Magnification Ring
- 9 Rangefinder Button
- 10 Photo Button
- 11 Power Button
- 12 Eyepiece / Diopter Adjustment Ring
- 13 Eyeguard
- 14 18650 Batteries

## 6. Description of Control Buttons and Shortcuts

Power Button 		
Current Screen, Menu, or Device Status	Short Press	Long Press
Device off	---	Power on the device
Home screen	Manually perform a non-uniformity correction	Power off the device / enter standby mode
Standby mode	Exit standby mode	---
Main menu	Return to the previous menu without saving changes	Power off the device

Menu Button 		
Current Screen / Menu	Short Press	Long Press
Home screen	Enter the quick menu	Enter the main menu
Main menu	Change menu options; enter the submenu; or confirm submenu changes and return to previous	Save and return to the home screen
Quick menu	Toggle through the menu options	Exit the quick menu
Reticle zeroing and pixel defect correction interface	Switch between the axis of movement (X and Y)	---
Quick menu	Toggle through the menu options	Exit the quick menu



Rangefinder Button 		
Current Screen / Menu	Short Press	Long Press
Home screen	Turn on the laser rangefinder in single ranging mode	Turn on the laser rangefinder in continuous ranging mode
Single ranging mode	Take a rangefinding measurement	Switch to continuous ranging mode
Continuous ranging mode	Switch to single rangefinding mode	Turn off the laser rangefinder

Photo Button 		
Current Screen / Menu	Short Press	Long Press
Home screen	Take a photo	Start / stop recording video

Rangefinder Button  + Photo Button 		
Current Screen / Menu	Short Press	Long Press
Home screen	---	Activate / deactivate reticle (Long press for 7 seconds)

Control Turret	
Current Screen / Menu	Rotate
Home screen	If PIP is OFF: rotate to adjust the digital zoom level of the observed image. If PIP is ON: rotate to adjust the digital zoom for the PIP image.
Quick menu	Switch menu options; move menu cursor Clockwise: Move left / down Counterclockwise: Move right / up
Main menu	
Reticle zeroing and pixel defect correction interface	Move the reticle position. Clockwise: Move left / down Counterclockwise: Move right / up

## 7. Quick Start Guide

### Step 1: Prepare to Use the ACE H50R

1. Compare the box contents to the accessories list and examine each for any shipping damage. See **Accessories** on page 4.
2. Check the lens to ensure there are no smudges or dirt present. Clean with the included lens cloth, if necessary.
3. Charge the built-in battery pack before using the ACE H50R for the first time. See **Charging the Built-in Battery Pack** on page 9.
4. Install the eyeguard (13).

### Step 2: Turn On the ACE H50R

1. Open the objective lens cap (2).
2. Long press the **Power** (⏻) **Button** for 2 seconds to power on the ACE H50R.
3. Rotate the eyepiece diopter adjustment ring (12) until the interface icons are clear.

**WARNING:** Do not point the objective lens toward intense energy sources, such as the sun. This may render the electronic components inoperative. The warranty does not cover damage caused by improper operation.

### Step 3: Adjust Settings in the Quick Menu

Short press the **Menu** (Ⓜ) **Button** to enter the quick menu to adjust the following settings (see **Using the Quick Menu** on page 19):

1. Set the color palette to white hot, black hot, red hot, color, violet, crimson, or viridian.
2. Select a screen brightness level, from 1–10.
3. Select an image sharpness level, from 1–10.
4. Select an image contrast level, from 1–10.

### Step 4: Adjust Device Settings

1. Long press the **Menu** (Ⓜ) **Button** to enter the main menu (see **Main Menu Options and Descriptions** on page 29 for detailed instructions) to:
  - a. Turn on Ultra-Clear mode.
  - b. Turn on the PIP window.
  - c. Set the non-uniformity correction (NUC) mode to automatic, manual, or background.

- d. Turn on the motion sensor.
  - e. Set the image hue to warm or cool.
  - f. Turn on recoil activated video.
  - g. Turn on the microphone.
  - h. Set the date and time.
  - i. Set the units of measure to yards or meters.
2. Rotate the **Control Turret** to adjust the stepped digital zoom level. The real time magnification, 3x to 24x appears in the status bar.
  3. Rotate the **Ocular Magnification Ring** to adjust the ocular magnification level from 1x to 3x.

### Step 4: Set Up the Reticle and Zero the ACE H50R

The reticle may be inactive when the ACE H50R is powered on for the first time. To activate the reticle, press and hold the **Rangefinder** (📏) and **Photo** (📷) **Buttons** at the same time for at least 7 seconds.

1. Adjust the reticle settings (see **Main Menu > Reticle** on page 30).
  - a. Set the reticle type to 1–7. A custom reticle is also available for purchase in the NOCPIX App.
  - b. Set the reticle color to black red, black green, white red, white green, black white, white black, red, or green.
  - c. Set the zeroing profile to A, B, C, D, E, F, or G.
2. Zero the rifle scope. See **Zeroing the ACE H50R** on page 21.
  - a. Select, or customize, a zero distance that matches the target distance.
  - b. Zero the reticle.

## 8. Charging the Built-in Battery Pack

The ACE H50R has a dual power supply: a built-in rechargeable lithium-ion battery pack and it comes with two optional auxiliary 18650 batteries. The ACE H50R supports a run time of 3.5 hours out of the box and 7 hours when using an 18650 battery. The built-in battery pack is not removable or replaceable. Please ensure the battery pack is fully charged before the first use.

To charge the battery pack:

1. Remove the USB-C port cover (4) by turning it counterclockwise.

2. Connect the USB-C end of the data cable to the USB-C port (4).
3. Connect the standard USB end of the data cable to:
  - a. Any standard USB 3.0 port on a laptop or computer; **OR**
  - b. The included 5V-2A USB power adapter, and plug the power adapter into an electrical outlet.
4. While charging:
  - a. The LED status indicator (15) next to the USB-C port will turn red. When the indicator LED turns green, the battery is fully charged.
  - b. A charging ⚡ icon appears above the battery status indicator in the lower-right corner of the screen.

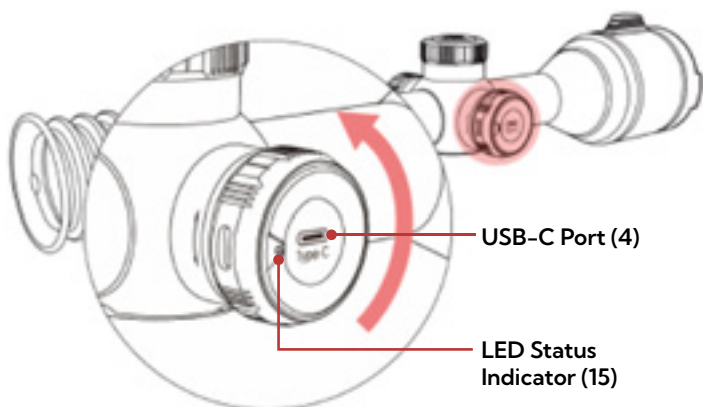

5. When fully charged, disconnect the data cable from the USB-C port and replace the USB-C port cover. Do not overcharge.

**WARNING:** Never charge the battery pack with a USB adapter that is greater than 5V-2A.

**NOTES:**

- You may charge and operate the ACE H50R at the same time.
- When the battery status icon turns red and only one bar remains, charge the battery right away to avoid over-discharge and a reduction in battery capacity or service life.
- Only the built-in battery pack will be charged while connected via the USB-C port.

## Charging the 18650 Batteries

1. Insert an 18650 battery (14) into the battery charger (16) following the polarity markings (A) inside the battery slot.
2. Connect the USB-C cable (17) to the USB-C port (B) on the battery charger.
3. Connect the standard USB end of the data cable to:
  - a. Any standard USB 3.0 port on a laptop or computer; **OR**
  - b. The included 5V-2A USB power adapter, and plug the power adapter into an electrical outlet.
4. During charging, the LED status indicator (C) on the battery charger will be solid red.

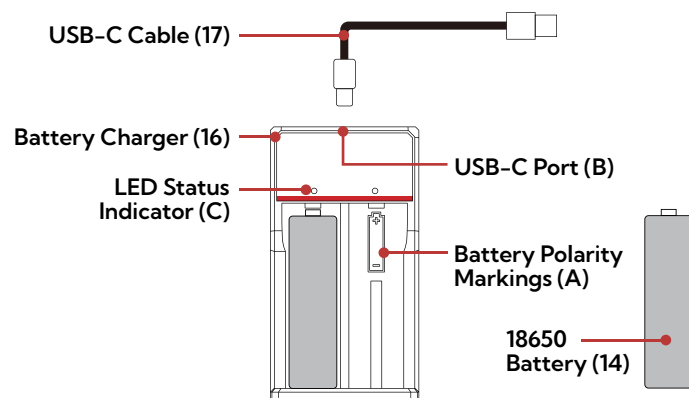

5. When the battery is fully charged, the LED status indicator will turn solid green. Remove the battery from the battery charger. Do not overcharge.

**NOTE:** When the LED status indicator flashes red, the battery charger is connected to a power source but no battery is installed.

**WARNING:** Never use the battery charger with a USB power adapter that is greater than 5V-2A.

## 9. Installing an 18650 Battery

The battery compartment allows the run time of the ACE H50R to be expanded to 8+ hours with the use of an optional 18650 battery. Ensure the 18650 battery is fully charged before installing it in the ACE H50R.

To install an 18650 battery:

1. Remove the battery cover by turning it counterclockwise.

2. Insert an 18650 battery into the battery compartment following the polarity markings inside the compartment. The positive **[+]** battery terminal faces in and the negative **[-]** terminal faces out.
3. Replace the battery cover.

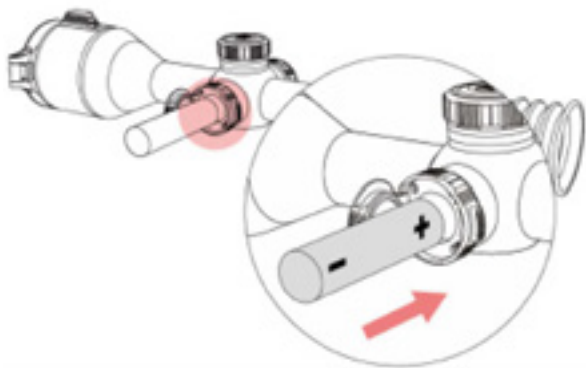

**WARNING:** Only 18650 batteries may be used with the ACE H50R. Using any other battery type may cause irreparable damage to the rifle scope or cause a fire. Any damage from using an improper battery will not be covered by warranty.

**WARNING:** Only use the factory-supplied battery charger to charge the included 18650 batteries. The use of any other charger may irreparably damage the battery or the charger and may cause a fire. Any damage from using an improper battery charger will not be covered by warranty.

## 10. Battery Status Indicators

The status indicator for the built-in battery pack appears in the lower-right corner of the screen.

If an 18650 battery is installed in the ACE H50R, its status indicator appears in the bottom-left corner.

The status indicator for the active battery (the battery currently being used to power the ACE H50R) is displayed in color (white or red), while the status indicator for the inactive battery is displayed in gray.



The fill level of the active battery status indicator indicates the current battery charge level. The battery charging ⚡ icon appears above the built-in battery status indicator when the ACE H50R is connected to an external power source. See the table below.

**NOTE:** Charge the battery promptly when its status indicator shows one bar (5–20%) to avoid over-discharge and potential damage to the battery.

ICON	STATUS
5 White Bars	81% – 100%
4 White Bars	61% – 80%
3 White Bars	41% – 60%
2 White Bars	21% – 40%
1 White Red Bar	5% – 20%; charge the battery promptly.
Charging Icon ⚡	The built-in battery is charging (external power is connected via the data cable).

## 11. Switching the Battery Power Supply

The ACE H50Rs dual power supply system works seamlessly to power the device:

- When the 18650 battery is installed and fully charged, it will be the preferred power source.
- If the power of the 18650 battery is low, or the 18650 battery is removed, the ACE H50R will automatically switch to the built-in battery pack as its primary power supply. Operation will not be interrupted during this time.
- When the ACE H50R is in use, the 18650 battery may be replaced at any time. During replacement, power will switch to the internal battery pack and then switch back to the new 18650 battery after replacement automatically.
- When the ACE H50R is connected via USB-C, the device will switch to the external power supply automatically, and the charging ⚡ icon will appear above its built-in battery's status indicator in the bottom-right corner.



## 12. Battery Safety Warnings

### WARNINGS:

- Do not use a power adapter or USB-C cable that has been modified or damaged.
- Do not expose the batteries to high temperatures or open flame, and do not immerse in water.
- Do not leave the batteries unattended while charging.
- Do not leave the batteries charging for long periods after full charge is reached. Charging time should not exceed 24 hours.
- Keep batteries out of the reach of children and pets.
- The batteries are equipped with short-circuit protection. However, any situation that may cause short-circuiting should be avoided.
- Do not disassemble, modify, hit, or drop the batteries.
- Do not connect the batteries to any external device with an electrical current that exceeds permitted levels.
- Do not connect an external device with a current supply that exceeds the 3.0 USB port.

To maintain optimal battery capacity and service life:

- Avoid storing a fully charged or discharged battery for long periods. Partial charging of the battery is necessary if the battery will be stored for an extended period.
- Do not charge an extremely cold battery. Allow the battery to warm up for about 45 minutes before charging.
- Charge the batteries at a temperature range from 32°F to 113°F; otherwise, the service life of the battery may be reduced.
- The recommended operating temperature range is -4°F to 122°F. Avoid using the batteries above the maximum or below the minimum recommended temperature range as this may decrease the battery capacity or service life.

## 13. External Power Supply

The ACE H50R supports the use of a 5V external power supply, such as a mobile power bank. To connect to an external power supply:

1. Connect the data cable (17) to the USB-C port (4).
2. Connect the other end of the USB-C cable to the external power supply. The ACE H50R will automatically switch to using the external power supply for power and it will begin charging the internal battery pack.

- a. A charging ⚡ icon appears above the battery status indicator for the built-in battery pack in the lower-right corner of the screen, indicating that the battery is charging.
  - b. The number of bars in the battery status icon will change to reflect the current charge level.
3. When the external power supply is turned off, the ACE H50R will switch to the 18650 battery, if installed, without turning off.
  4. If no 18650 battery is installed or the 18650 battery level is low, the ACE H50R will switch to the built-in battery pack, instead of shutting down.

**NOTE:** Do not connect the ACE H50R to an external device with a power supply that exceeds the 3.0 USB cable.

## 14. Operating Instructions

### WARNING!

Don't point the objective lens towards any intense energy sources, such as laser radiation or the sun. This may render the electronic components inoperative. The warranty does not cover damage caused by improper operation.

### Using the Control Buttons

The ACE H50R is operated via four control buttons and a large metal tactile control turret. The large, easy-to-find control turret provides audible and tactile feedback when twisted. The control buttons can be used to perform shortcut operations from the home screen, as well as in the menu and full-screen interfaces. See **Description of Control Buttons and Shortcuts** on page 6 for shortcut button details.

### Powering On



1. Open the objective lens cap (2).
2. Long press the **Power (⏻) Button** for 2 seconds to turn on the ACE H50R. The Nocpix logo will appear.
3. To determine the current charge of the built-in battery pack, check the battery status indicator in the lower-right corner of the screen.

### Powering Off and Entering Standby

To power off the ACE H50R:

1. Press and hold the **Power (⏻) Button**. The shutdown screen will open, showing a 3-second countdown.

2. Continue holding the **Power**  **Button** until the countdown completes.
3. "Data saving..." appears on the screen and the ACE H50R will shut down automatically after the data finishes saving.

**NOTE:** Releasing the **Power**  **Button** at any time before the 3-second countdown reaches zero will stop the shutdown process and the rifle scope will enter standby mode. Short press the **Power**  **Button** to exit standby.



**WARNING:** If using an external power supply and no battery is installed, do not remove the power supply when saving data, as the data may not be saved.

## STANDBY MODE

Standby mode may be activated to conserve the battery life of the rifle scope. When in standby mode, short press the **Power**  **Button** to exit standby and return to the home screen.

### Manually Enter Standby Mode

The user may enter standby mode manually at any time.

1. From the home screen, long press the **Power**  **Button** to bring up the shutdown screen.
2. Release the **Power**  **Button** before the 3-second countdown finishes to enter standby.
3. Press the **Power**  **Button** to exit standby.

### Automatically Enter Standby Mode

The rifle scope may be set to enter standby mode automatically.

1. In the main menu, turn automatic standby on. When turned on, the ACE H50R will automatically enter standby after 5 seconds of inactivity. See **Main Menu > Standby** on page 43.
2. Press any button or move the rifle scope to exit standby.

### AUTOMATIC STANDBY NOTES:

- When automatic standby is turned **on**:
  - After the set number of minutes of inactivity, the ACE H50R will enter standby automatically when it is tilted up or down at an angle of more than 70° or left or right at an angle of more than 30°.
  - The ACE H50R will not enter standby mode while it is in a level (horizontal) position.
- When auto standby is turned **off**, the rifle scope will operate until the batteries run out.

## Adjusting the Focus

### ADJUSTING THE DIOPTER/EYEPIECE

1. Rotate the eyepiece diopter adjustment ring (**12**) at the rear of the ACE H50R right or left until the user interface is clear.
2. Look closely to ensure all icons, the status bars, and the reticle appear sharp and in focus. No additional diopter adjustments are required unless the user wishes to make changes.

#### NOTES:

- After the initial adjustment, there is no need to rotate the eyepiece adjustment ring (**12**) for long distances or other conditions.
- If necessary during standard use, the objective lens focus ring (**3**) may be rotated to adjust fine focus on the target object being observed. See **Focusing the Objective Lens** below.

### FOCUSING THE OBJECTIVE LENS



To adjust the focus on the target object:

1. Rotate the objective lens focus ring (**3**) left or right to adjust fine focus.

**NOTE:** Re-adjusting the focus will be necessary if the distance to the target changes.

## Activating / Deactivating the Reticle

The reticle may be inactive when the ACE H50R is powered on for the first time. To activate the reticle, or to deactivate it at a later time:

1. From the home screen, press and hold the **Rangefinder**  and **Photo**  **Buttons** at the same time for at least 7 seconds.

## Status Bar Overview

The status bars at the top and bottom of the screen show information on the operating status of the ACE H50R.

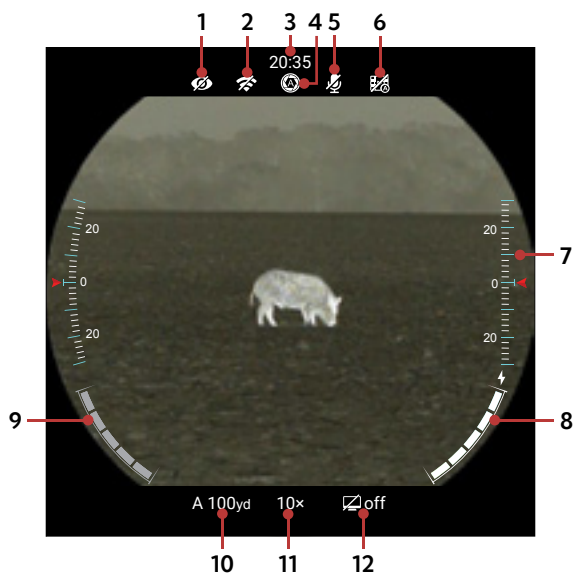

- 1 Ultra-Clear:** Shows the Ultra-Clear status, on or off .
- 2 Wi-Fi:** Shows the Wi-Fi status, on or off .
- 3 Time:** Shows the current time in 24-hour format.
- 4 Non-Uniformity Correction (NUC) Mode:** Shows the selected non-uniformity correction (NUC) mode, automatic , manual , or background . When automatic mode is selected, a countdown timer icon will appear when 5 seconds remain until a NUC.
- 5 Microphone:** Shows the microphone status, on or off .
- 6 Recoil Activated Video:** Shows the recoil activated video status, on or off .
- 7 Gravity Sensor:** The two gravity sensor scales (tilt and pitch) display on either side of the screen when the gravity sensor is turned on.
- 8 Built-in Battery Status Indicator:** Shows the status of the built-in battery pack. When the ACE H50R is receiving power from the battery pack, the battery indicator is in color; when inactive, the battery indicator is gray. The charging icon appears above the status indicator when the ACE H50R is connected to an external power source.
- 9 18650 Battery Status Indicator:** Shows the status of the rechargeable 18650 battery. When the ACE H50R is receiving power from the 18650 battery, the battery indicator is in color; when inactive, the battery indicator is gray.

- 10 Zeroing Profile & Distance:** Shows the selected zero profile, A, B, C, D, E, F, or G, and the zero distance.
- 11 Total Magnification:** Shows the total magnification, 3x to 24x.
- 12 Standby:** Shows the standby icon and status, on or off.

## Using the Quick Menu

In the quick menu, the color palette, screen brightness, image contrast, image sharpness, and zeroing distance can be quickly adjusted.







- From the home screen, short press the **Menu** Button to enter the quick menu.
- Rotate the **Control Turret** to switch between the quick menu items, described below. The selected menu item turns blue.
  - (**Color Palette**): Short press the **Menu** Button to set the color palette to white hot, black hot, red hot, color, violet, crimson, or viridian.
  - (**Screen Brightness**): Short press the **Menu** Button to select a screen brightness level, from 1–10.
  - (**Image Contrast**): Short press the **Menu** Button to select an image contrast level, from 1–10.
  - (**Image Sharpness**): Short press the **Menu** Button to select an image sharpness level, from 1–10.
  - (**Zeroing Distance**): Short press the **Control Turret** to change the selected zeroing distance within the currently selected zeroing profile. Only the zero distances in the selected profile will be available for selection. The selected zero profile and distance appear in the bottom status bar.
- Long press the **Menu** Button to save any changes and return to the home screen.

- Short press the **Power**  **Button** to return to the home screen without saving.
- After 7 seconds of inactivity, the system will automatically save any changes and return to the home screen.





## Navigating the Main Menu



- From the home screen, long press the **Menu**  **Button** to enter the main menu.
- Rotate the **Control Turret** to switch between the menu items.
- A blue menu icon indicates the cursor position.
- Short press the **Menu**  **Button** to:
  - Change the parameters for the selected menu option; **OR**
  - Enter the submenu; **OR**
  - Confirm submenu changes and return to the previous menu.
- Long press the **Menu**  **Button** to confirm any changes and return to the home screen.
- Short press the **Power**  **Button** to return to the previous menu without saving.
- After 7 seconds of inactivity, the menu will automatically close and the interface will return to the home screen. Changes (except changes to toggle on / off menu items, such as Ultra-Clear and Wi-Fi) are not saved automatically.

## 15. Zeroing the ACE H50R



The ACE H50R features a “freeze” zeroing method. To zero the ACE H50R:

1. Set a suitable target at the desired zero distance.
2. Confirm that the rifle is empty, safe, and pointed in a safe direction, with no ammunition near the weapon.
3. Adjust the image and device settings following the steps in the Quick Start Guide on page 8, if you have not done so already.
4. Select the zeroing profile, A, B, C, D, E, F, or G.
5. Based on the distance to the target you wish to zero, select a preset zero distance, **OR** customize one of the preset zero distances to match. The ACE H50R supports custom zeroing distances of 1 to 999 meters or 1 to 999 yards.
6. Ensure a stable platform and natural shooting position is achieved behind the rifle.
7. Load ammunition, aim, and take one good shot at the target.
8. Make your rifle safe and observe the location of impact on the target.
9. If the point of impact does not match the point of aim (the center of the reticle), adjust the X/Y position of the reticle.
10. In the submenu for the selected zero distance, center the reticle on the aiming point and freeze the image view.
  - a. Rotate the **Control Turret** to move to the image freeze  icon.
  - b. Short press the **Menu**  **Button** to freeze the image.
11. Select the axis (X or Y) along which to move the reticle:
  - a. Rotate the **Control Turret** to move between **X** and **Y**.
  - b. Short press the **Menu**  **Button** to select the desired axis. Adjust the X/Y position of the reticle until the reticle matches the point of impact.
  - c. Rotate the **Control Turret** counterclockwise to move in the positive direction: X= Right and Y= Up.
  - d. Rotate the **Control Turret** clockwise to move in the negative direction: X= Left and Y= Down.
12. Long press the **Menu**  **Button** to save the reticle position.
13. Take a confirmation shot—the point of impact should now match the point of aim. If not, adjust the X/Y position of the reticle again.

For detailed Zeroing instructions, please see **Zeroing menu > Reticle Zeroing** on page 33.

## 16. Non-Uniformity Correction

A non-uniformity correction (NUC) allows a thermal imager's sensors to correct its pixels and eliminate any image defects caused by pixel drift. A NUC will be performed automatically each time the ACE H50R is powered on.

The ACE H50R has three NUC modes, automatic, manual, and background. The icon for the selected NUC mode, automatic , manual , or background , appears in the top status bar.

### Automatic Mode

In automatic mode, the ACE H50R will perform a NUC automatically according to the internal software algorithm. There is no need to close the objective lens cap as the ACE H50R's internal shutter covers the sensor.

When automatic mode is turned on, a countdown timer icon will appear when 5 seconds remain until a NUC. Short pressing the Power button before the 5-second countdown completes will cancel the pending automatic NUC. The timer will appear only after the microbolometer temperature has stabilized—after approximately 10 minutes of continuous operation of the ACE H50R.

**NOTE:** A manual NUC (see below) may be performed at any time while in Automatic mode.

### Manual Mode

In manual mode, the user independently determines the need to perform a NUC based on the quality of the observed image. It is not necessary to close the objective lens cap during a manual NUC, as the internal shutter covers the sensor.

To perform a manual NUC while in manual or automatic mode:

1. From the home screen, short press the **Power**  **Button**.
2. A manual NUC is performed instantly.

### Background Mode

In background mode, the user independently determines the need to perform a background NUC based on the quality of the observed image. A background NUC uses less power than an automatic or manual NUC because it does not use the imager shutter to cover the sensor; instead, the user must close the lens cap.

To perform a background NUC while in background mode:

1. Close the objective lens cap (2).
2. From the home screen, short press the **Power**  **Button**.

3. A prompt to close the lens cap appears onscreen. The background NUC starts after about 2 seconds.

**NOTE:** If the lens is not properly covered, a temporary "image burn" will remain in the image until the next non-uniformity correction. This "image burn" is temporary and is not a defect or sign of permanent damage.



## 17. Photography and Video Recording

The ACE H50R is equipped with video recording and image capture. All videos and photos are automatically saved to the built-in 64 GB memory storage.

**NOTE:** Photo and video files are named with the time and date; therefore, it is recommended to set the date and time before using the photo and video functions. See **Settings Menu > Date and Time** on page 48. Alternatively, the date and time may be synchronized in the NOCPIX App.

### Photography

To take a photo:



1. From the home screen, short press the **Photo**  **Button**.
2. The image will freeze for 0.5 seconds and the camera  icon will appear briefly in the upper-right corner of the screen to indicate a photo was taken.



**NOTE:** A red warning icon  appears next to the camera icon in the upper-left corner of the screen when insufficient memory storage is available. Transfer video and image files to other storage media to free up space on the memory card.

## Video Recording

To record video:



1. Turn on the microphone in the main menu. See **Main Menu > Microphone** on page 44.
2. From the home screen, long press the **Photo**  **Button** to start a video recording.
3. When the video recording starts, the recording timer, in MM:SS (minute, second) format, appears in the upper-right corner of the screen.
4. When recording, short press the **Photo**  **Button** to take a photo.
5. Long press the **Photo**  **Button** to stop and save the video recording.



## Recoil Activated Video

When recoil activated video (RAV) is turned on, the rifle scope will record 8 seconds before the shot and 92 seconds after the shot. See **Main Menu > Recoil Activated Video** on page 43 for instructions.

### NOTES:

- The RAV status, on  or off , appears in the top status bar.
- The video recording timer, in HH:MM:SS (hour, minute, second) format, will appear in the upper-right corner of the screen when RAV is recording.
- Long press the **Photo**  **Button** to stop and save the recoil activated video recording at any time.
- When multiple shots are taken within the same 30-second period, only one video will be taken.
- When recoil activated video recording is turned on, standard video recording is unavailable.



## Video and Photography Notes

- You may enter and navigate the menu during video recording.
- The user interface (the status bar, icons, and menu) is captured in recorded video or photo files.
- Recorded photos and videos are saved to the memory card.
  - Photos are saved as PIC\_HHMMSS.jpg.
  - Videos are saved as VIDEO\_HHMMSS.mp4.
  - RAV videos are saved as RAV\_HHMMSS.mp4.
  - HHMMSS is hour, minute, and second.
- The number of recorded files is limited only by the capacity of the internal memory.
- Regularly check the available memory storage space and move video footage and images to other storage media to free up space on the memory card.

## 18. Accessing the Internal Memory

When the ACE H50R is turned on and connected to a computer via the included data cable, it is recognized by the computer as a flash memory (USB) drive. This allows the user to access the saved multimedia files and copy or delete any desired files.

To access the internal memory:

1. Turn on the rifle scope.
2. Connect the ACE H50R to your computer via the included data cable (14).
3. Double-click **My Computer** on your computer desktop.
4. Double-click to open the device named **NOCPIX**.
5. Double-click to open the device named **ACE** to access the built-in memory. Recorded photos and videos are separated into folders by date.
6. Select the desired files or folders to copy or delete.

## 19. Using The NOCPIX App

The ACE H50R can be operated using the NOCPIX App when connected to a tablet or smartphone or via Wi-Fi.

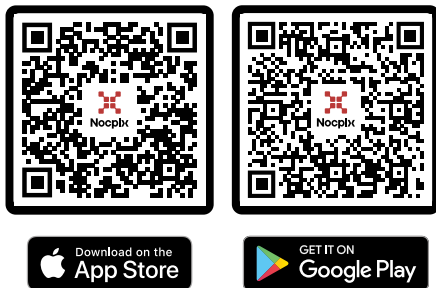

1. Download the App for free and install it on your device:
  - a. Scan a QR code to download it from the App Store or Google Play; **OR**
  - b. Download the App from any app store.
2. Connect the ACE H50R to Wi-Fi:
  - a. Turn on the Wi-Fi. See **Main Menu > Wi-Fi** on page 36 for instructions.
  - b. Open the App and press the **ViewFinder**  icon on the home screen. Then, click the **Connect Device WiFi button**.
  - c. On the mobile device, go to **Settings > Wi-Fi**.
  - d. Select the ACE H50R from the list of Wi-Fi networks. It will appear in the list as "ACE HR50R\_YYYYYYY" where XXXXX is the model number and YYYYYYY is the seven-digit device serial number.
  - e. Enter the Wi-Fi password and tap the **Join button**. The default password is 12345678.
3. Operate the ACE H50R via the App:
  - a. Take real-time photos and videos, with or without audio.
  - b. View, share, download, and delete photos and videos taken via the App, which are saved to the mobile device.
  - c. Change the Wi-Fi password and SSID.
  - d. Synchronize the date and time from the mobile device.
  - e. Update the ACE H50R firmware.
  - f. Adjust ballistic menu parameters.

**NOTE:** When a factory reset is performed, the Wi-Fi SSID and password are reset to the defaults, ACE HR50R\_YYYYYYY and 12345678. See **Settings Menu > Factory Reset** on page 50.

## 20. Integrated Laser Rangefinder

The ACE H50R is equipped with an integrated, precision laser rangefinder which allows the user to measure the distance to objects up to 1300 yards away, with  $\pm 1$ -yard accuracy. The laser rangefinder has two ranging modes: continuous and single-measurement capture. Continuous ranging allows the user to adjust quickly to changing distances for better shot placement.





**CAUTION:** Do not stare directly into the laser.





The rangefinder interface has the following features:

- 1 **Cursor:** The blue rangefinder reticle  appears in the center of the screen.
- 2 **Mode:** The selected ranging mode, SGL (single) CONT (continuous) or appears in the upper-right corner.
- 3 **Rangefinding Measurement:** The target distance appears in the upper-right corner.

To use the laser rangefinder in continuous ranging mode:

1. Long press the **Rangefinder**  **Button** to turn on the laser rangefinder in continuous ranging mode.
2. Locate the target.
3. The distance to the target indicated by the cursor will be refreshed automatically by the rangefinder every second.
4. Short press the **Rangefinder**  **Button** to switch to single ranging mode.
5. Long press the **Rangefinder**  **Button** to turn off the laser rangefinder.

To use the laser rangefinder in single ranging mode:

1. Short press the **Rangefinder**  **Button** to turn on the laser rangefinder in single ranging mode.
2. Locate the target, and short press the **Rangefinder**  **Button** to take a rangefinding measurement.
3. Long press the **Rangefinder**  **Button** to switch to continuous ranging mode.
4. Long press the **Rangefinder**  **Button** a second time to turn off the laser rangefinder.

## ACCURACY NOTES:

- The measurement accuracy and maximum range depend on the reflection ratio on the target surface, the angle at which the laser beam falls on the target surface, and environmental conditions. Reflectivity depends on the surface texture, color, size, and shape of the object. Typically, a glossy, bright surface will have higher reflectivity than a darker surface.
- Ranging performance can degrade in bright conditions or when ranging towards the sun.
- The measurement accuracy can be affected by fog, smog, heavy rain, snow, and other weather conditions. It can also be affected by a low battery or a dirty or smudged objective lens.
- Measuring the range to a small target is more difficult than measuring the range to a large target.

## 21. Digital Zoom

The ACE H50R uses stepped digital zoom and can quickly increase the base magnification by enlarging the image from 1 to 8 times digitally.

To use digital zoom:

1. Rotate the **Control Turret** to adjust the digital zoom level.
2. The total magnification, 3x, 4x, 5x, 6x, 7x, 8x, 9x, 10x, 11x, 12x, 14x, 16x, 18x, 20x, 22x, or 24x, is shown in the bottom status bar.

**NOTE:** If PIP is turned on, rotating the **Control Turret** will adjust the digital zoom level for the PIP image.

## 22. Ultra-Clear Mode

Ultra-Clear mode improves the image quality in inclement weather conditions, such as rain, fog, high humidity, or high temperatures as these conditions all result in lower thermal contrast. Ultra-Clear mode enhances the NETD value of the thermal sensor and improves the sensor's response rate to these challenging environment conditions. See **Main Menu > Ultra-Clear** on the next page.

Ultra-Clear mode provides:

- Improved image quality and clarity; images are crisper and sharper.
- Increased image detail.
- Improved recognition of observed targets.

## 23. Main Menu Options and Descriptions

Menu and submenu options, from top to bottom are:







- **Main Menu:** Ultra-Clear, Reticle, Zeroing, PIP, Wi-Fi, Calibration, Motion Sensor, Gallery, Ballistic Calibration, Image Hue, Recoil Activated Video, Standby, Microphone, Pixel Defect Correction, Settings.
  - **Reticle Menu:** Reticle Type, Reticle Color, Zeroing Profile.
  - **Zeroing Menu:** Reticle Zeroing, Customize Zero Distance.
  - **Settings Menu:** Date, Time, Languages, Unit, Firmware Update, Factory Reset, Info.

Menu option details, descriptions, and navigation instructions are listed in order on the following pages.

### Ultra-Clear

#### Turn Ultra-Clear mode on / off

When Ultra-Clear mode is turned on, the image contrast is enhanced, which is suitable for rainy, foggy, or low-contrast conditions.

1. Long press the **Menu**  **Button** to enter the main menu.
2. Rotate the **Control Turret** to select the Ultra-Clear  menu item.
3. Short press the **Menu**  **Button** to turn Ultra-Clear on / off. The Ultra-Clear status, on  or off , appears in the top status bar.
4. Long press the **Menu**  **Button** to return to the home screen.



**NOTE:** When Ultra-Clear mode is turned on and off, the ACE H50R will automatically perform a shuttered non-uniformity correction.





## Reticle



Select the zeroing profile, reticle type, and reticle color

1. Long press the **Menu**  **Button** to enter the main menu.
2. Rotate the **Control Turret** to select the reticle  menu item.
3. Short press the **Menu**  **Button** to enter the reticle submenu.



## RETICLE MENU > RETICLE TYPE

Select the reticle type

1. In the reticle submenu, rotate the **Control Turret** to select the reticle type  menu item.
2. Short press the **Menu**  **Button** to enter the submenu.
3. Rotate the **Control Turret** to move through reticle type options, 1–7 (see below). The reticle changes as the cursor moves through the reticle types. A custom reticle is also available for purchase in the NOCPHX App.
4. Long press the **Menu**  **Button** to confirm the selection and return to the home screen.

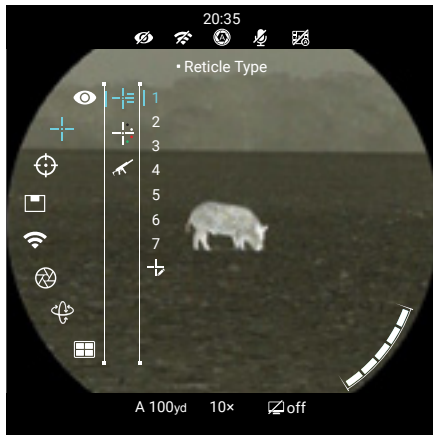

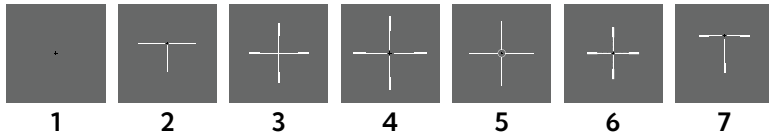

### Reticle Types



## RETICLE MENU > RETICLE COLOR

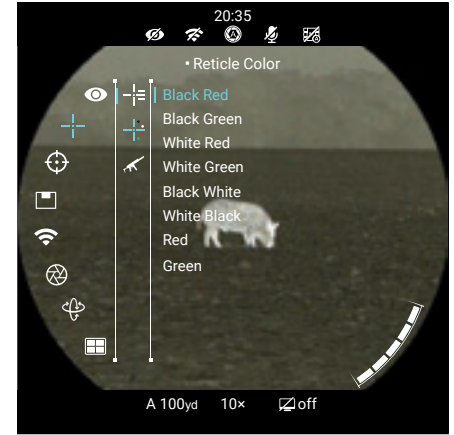

Select the reticle color

1. In the reticle submenu, rotate the **Control Turret** to select the reticle color  menu item.
2. Short press the **Menu**  **Button** to enter the submenu.
3. Rotate the **Control Turret** to move through reticle color options, black red, black green, white red, white green, black white, white black, red, or green. The reticle color changes as the cursor moves through the color options.
4. Long press the **Menu**  **Button** to confirm the selection and return to the home screen.



## RETICLE MENU > ZEROING PROFILE

Select the zeroing profile

1. In the reticle submenu, rotate the **Control Turret** to select the zeroing profile  menu item.
2. Short press the **Menu**  **Button** to enter the zeroing profile submenu.
3. Rotate the **Control Turret** to move through zeroing profile options, A, B, C, D, E, F, or G. The selected zeroing profile appears in the bottom status bar.
4. Long press the **Menu**  **Button** to confirm the selection and return to the home screen.



## Zeroing

### Select or customize a zero distance

In the zeroing menu, you can add a new zero distance or select a zero distance in the list to edit it or adjust the reticle position. The ACE H50R supports up to 10 zero distances.



**NOTE:** Before selecting or adding a new zero distance, you must select a zeroing profile, A, B, C, D, E, F, or G. See **Reticle Menu > Zeroing Profile** on page 31.

1. Long press the **Menu (M) Button** to enter the main menu.
2. Rotate the **Control Turret** to select the zeroing  menu item.
3. Short press the **Menu (M) Button** to enter the zeroing submenu.

### ZEROING MENU > ZERO DISTANCE SUBMENU

#### Add or select a zero distance

To add a new zero distance:

1. In the zeroing menu, rotate the **Control Turret** to move to the add  icon.
2. Short press the **Menu (M) Button** to add a new zero distance. A blue arrow will appear above and below the far-left digit of the new zero distance to mark the cursor location.
3. Rotate the **Control Turret** to increase or decrease the value of the selected digit from 0–9.
4. Short press the **Menu (M) Button** to switch between the three digits. The two blue arrows move to indicate the selected digit.
5. Short press the **Power (P) Button** to return to the previous menu without saving changes; **OR**
6. Long press the **Menu (M) Button** to save the new zero distance and return to the home screen.



To select a zero distance:



1. In the zeroing menu, rotate the **Control Turret** to select a zero distance.
2. Short press the **Menu (M) Button** to enter the submenu for the selected zero distance.
3. In the submenu for the selected zero distance, you may:
  - a. Select the reticle zeroing  menu item to adjust the X/Y position of the reticle. See **Reticle Zeroing** below.
  - b. Select the zero distance to edit it. See **Zeroing Menu > Customize Zero Distance** on page 35.







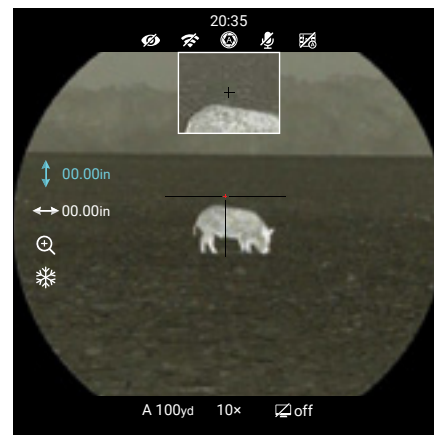

### ZEROING MENU > ZERO DISTANCE SUBMENU > RETICLE ZEROING

#### Adjust the reticle position of the selected zero distance

In the reticle zeroing interface, the X/Y position of the reticle may be adjusted to match the point of impact.

1. In the submenu for the selected zero distance, short press the **Menu (M) Button** to select the reticle zeroing  menu item and enter the reticle zeroing interface.
2. The interface has the following features:
  - 1 Y-Axis  Icon:** Vertical point of impact change (in cm or inches).
  - 2 X-Axis  Icon:** Horizontal point of impact change (in cm or inches).





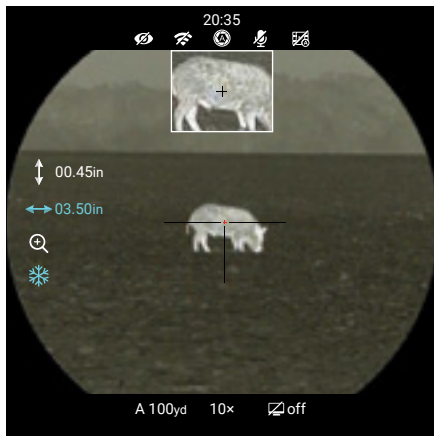

3. **Zoom  Icon:** Select to change the digital zoom level.
  4. **Freeze  Icon:** Select to freeze the image. When frozen, the icon turns from white to blue. Select a second time to unfreeze the image.
  5. **Reticle:** Shows the new reticle position.
  6. **Red Cursor:** Indicates the center of the original reticle position.
3. In the submenu for the selected zero distance, center the reticle on the aiming point and freeze the image view.
    - a. Rotate the **Control Turret** to move to the image freeze  icon.
    - b. Short press the **Menu  Button** to freeze the image. The freeze icon will turn from white to blue.
  4. Adjust the digital zoom level, as needed:
    - a. Rotate the **Control Turret** to move to the zoom  icon.
    - b. Short press the **Menu  Button** to toggle through the digital zoom options 3x, 6x, 9x, 12x, 15x, 18x, 21x, 24x. The selected real-time amplification appears in the bottom status bar.

5. Select the axis (X or Y) along which to move the reticle:
  - a. Rotate the **Control Turret** to move between X and Y. The axis icon will turn from white to blue to mark the cursor location.
  - b. Short press the **Menu  Button** to select the desired axis. The selected axis will begin flashing.



6. Adjust the X/Y position of the reticle until the reticle matches the point of impact.
  - a. X (horizontal) is the windage and Y (vertical) is the elevation.
  - b. Upon moving the reticle, a red cursor appears onscreen, representing the original position of the reticle.
  - c. Rotate the **Control Turret** counterclockwise to move in the positive direction: X= Right and Y= Up.
  - d. Rotate the **Control Turret** clockwise to move in the negative direction: X= Left and Y= Down.

- e. Rotate one click to move the cursor in the corresponding direction by 1 pixel. One full rotation (20 clicks) is equivalent to 20 pixels.
  - f. When adjusting your zero at a distance of 50 yards, one click will change the impact point by 0.22" as shown in the X and Y coordinate displays. At 100 yards that same click moves 0.43". At 200 yards one click moves 0.86".
  - g. The distance of your X/Y adjustments will update automatically if you change your zero distance, for example from 100 to 200 yards.
7. Short press the **Menu  Button** to save the position for the selected axis and deselect it. The deselected axis will change from blue to white.
  8. Repeat steps 5–7 to adjust the reticle position along the second axis if needed.
  9. Long press the **Menu  Button** to save the reticle position for both axes and return to the home screen.
  10. A popup window shows the message "Do you want to keep these settings?" and two options, Yes and No. Yes is selected by default.
  11. Short press the **Menu  Button** to select **Yes** to save the new reticle position and exit to the home screen. The screen will show "Saving"; **OR**
  12. Rotate the **Control Turret** to move to **No** and short press the **Menu  Button** to exit to the main menu without correcting any defective pixels.
  13. Take a confirmation shot—the point of impact should now match the point of aim. If not, adjust the X/Y position of the reticle again.

## ZEROING MENU > ZERO DISTANCE SUBMENU > CUSTOMIZE ZERO DISTANCE

### Edit a selected zero distance

1. In the submenu for the selected zero distance, rotate the **Control Turret** to move to the zero distance.
2. Short press the **Menu  Button** to edit the selected zero distance. A blue arrow will appear above and below the far-left digit to mark the cursor location.



3. Rotate the **Control Turret** to increase or decrease the value of the selected digit from 0–9.
4. Short press the **Menu (M) Button** to switch between the three digits. The two blue arrows move to indicate the selected digit.
5. Short press the **Power (P) Button** to return to the previous menu without saving changes; **OR**
6. Long press the **Menu (M) Button** to save the edited zero distance and return to the previous menu.

## PIP

### Turn PIP on / off

1. Long press the **Menu (M) Button** to enter the main menu.
2. Rotate the **Control Turret** to select the PIP  menu item.
3. Short press the **Menu (M) Button** to turn PIP on / off.
4. Long press the **Menu (M) Button** to return to the home screen.





**NOTE:** If PIP is turned on, rotating the **Control Turret** will adjust the digital zoom level for the PIP image.

## Wi-Fi

### Turn Wi-Fi on / off





Turn on Wi-Fi to operate the ACE H50R via the NOCPix App.

1. Long press the **Menu (M) Button** to enter the main menu.
2. Rotate the **Control Turret** to select the Wi-Fi  menu item.
3. Short press the **Menu (M) Button** to turn Wi-Fi on / off. The Wi-Fi status, on  or off , appears in the top status bar.
4. Long press the **Menu (M) Button** to return to the home screen.



## Calibration

### Turn automatic non-uniformity correction (NUC) mode on / off

1. Long press the **Menu (M) Button** to enter the main menu.
2. Rotate the **Control Turret** to select the calibration  menu item.
3. Short press the **Menu (M) Button** to enter the submenu.
4. Rotate the **Control Turret** to move through the NUC mode options, Automatic, Manual, and Background. The selected NUC mode, automatic , manual , or background , appears in the top status bar.
5. Long press the **Menu (M) Button** to confirm the selection and return to the home screen.



## Motion Sensor

### Turn the motion sensor on / off

1. Long press the **Menu (M) Button** to enter the main menu.
2. Rotate the **Control Turret** to select the motion sensor  menu item.
3. Short press the **Menu (M) Button** to turn the motion sensor on / off.







- When the motion sensor is turned on, the tilt angle appears on the left side of the screen and the pitch angle appears on the right side.
- Long press the **Control Turret** to save and return to the home screen.







## Gallery

### View photos and videos saved to the device

- Long press the **Menu ** **Button** to enter the main menu.
- Rotate the **Control Turret** to select the gallery  menu item.
- Short press the **Menu ** **Button** to enter the submenu.
- Rotate the **Control Turret** to move through the multimedia folders. Folders are named by date in YYYY.MM.DD format.
- Short press the **Menu ** **Button** to select a folder, then rotate the **Control Turret** to navigate through the image and video files. A thumbnail of the selected file appears on the right side of the screen.





- Short press the **Menu ** **Button** to view an image or video in full screen. When viewing video files, short press the **Menu ** **Button** to play and pause the video.
- Short press the **Power ** **Button** to return to the list of files.
- Long press the **Menu ** **Button** to return to the home screen.





## Ballistic Calculation

### Adjust the ballistic calculation settings

- Long press the **Menu ** **Button** to enter the main menu.
- Rotate the **Control Turret** to select the ballistics calculation  menu item.
- Short press the **Menu ** **Button** to enter the submenu.

### BALLISTICS MENU > BALLISTICS CALCULATION

#### Turn ballistic calculation on / off

- In the ballistics submenu, rotate the **Control Turret** to select the ballistic calculation menu item.
- Short press the **Menu ** **Button** to turn ballistic calculation on / off.
- Long press the **Menu ** **Button** to confirm the selection and return to the home screen.



## BALLISTICS MENU > PROFILE

### Select a ballistic profile

1. In the reticle submenu, rotate the **Control Turret** to select the profile menu item.
2. Short press the **Menu** (M) **Button** to enter the submenu.
3. Rotate the **Control Turret** to move through profile options, 1–5.
4. Long press the **Menu** (M) **Button** to confirm the selection and return to the home screen.

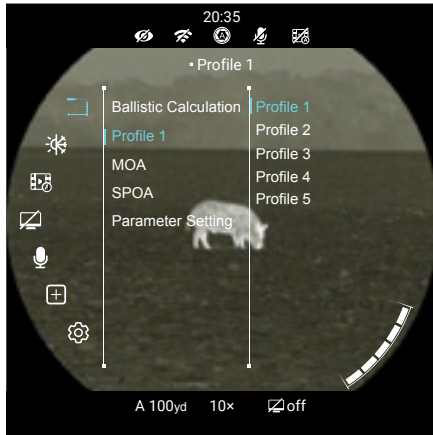

**NOTE:** The ballistic profile name can be customized in the NOCPIX App.

## BALLISTICS MENU > MOA

### Set the measurement to MOA or mil

1. In the reticle submenu, rotate the **Control Turret** to select the MOA menu item.
2. Short press the **Menu** (M) **Button** to enter the submenu.
3. Rotate the **Control Turret** to move through the options, MOA and mil.
4. Long press the **Menu** (M) **Button** to confirm the selection and return to the home screen.

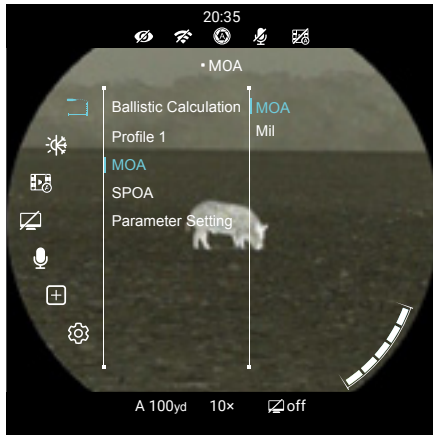

## BALLISTICS MENU > SPOA

### Set the suggested point of aim (SPOA)

1. In the reticle submenu, rotate the **Control Turret** to select the SPOA menu item.
2. Short press the **Menu** (M) **Button** to enter the submenu.
3. Rotate the **Control Turret** to move through the options, "x", "+", "\*", ". . . . .", and Move Reticle.
4. Long press the **Menu** (M) **Button** to confirm the selection and return to the home screen.

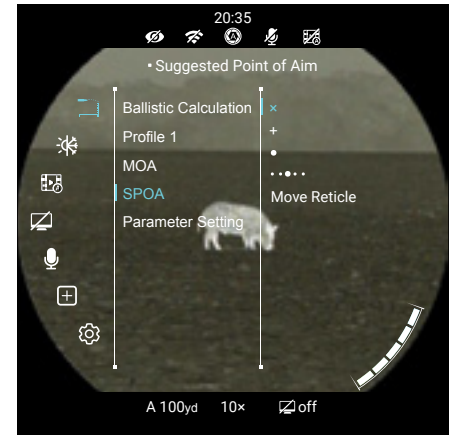

**NOTE:** When SPOA is set to Move Reticle, the ACE will automatically move the original reticle to the suggested point of aim.

## BALLISTICS MENU > PARAMETER SETTING

### Set parameters for bullets, rifles, and the environment

1. In the reticle submenu, rotate the **Control Turret** to select the parameter setting menu item.
2. Short press the **Menu** (M) **Button** to enter the submenu.
3. Rotate the **Control Turret** to move through the parameters and short press the **Menu** (M) **Button** to begin editing a parameter.



4. Rotate the **Control Turret** to move through the parameter options.
5. Long press the **Menu (M) Button** to confirm the selection and return to the home screen.

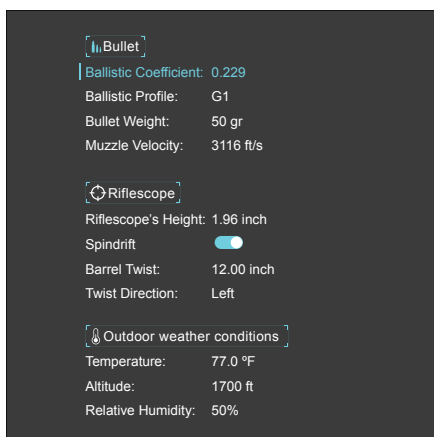

#### NOTES:

- Parameters can be adjusted in the NOCPIX App.
- When SPOA is set to Move Reticle, the ACE will automatically move the original reticle to the suggested point of aim.

## Image Hue 🌈

### Toggle between warm and cool image hue modes

1. Long press the **Menu (M) Button** to enter the main menu.
2. Rotate the **Control Turret** to select the image hue 🌈 menu item.
3. Short press the **Menu (M) Button** to toggle between warm 🌞 mode (toggle is on) and cool ❄️ mode (toggle is off).
4. Long press the **Menu (M) Button** to return to the home screen.



#### NOTES:

- Cool mode provides a brighter image and warm mode provides a softer image and reduces eye strain.
- Image hue is available when using the white hot or black hot color palette.

## Recoil Activated Video 📹

### Turn recoil activated video on / off

1. Long press the **Menu (M) Button** to enter the main menu.
2. Rotate the **Control Turret** to select the recoil activated video 📹 menu item.
3. Short press the **Menu (M) Button** to turn recoil activated video on / off. The RAV status, on 📹 or off 📹, appears in the top status bar.
4. Long press the **Control Turret** to confirm the selection and return to the home screen.



#### NOTES:

- When recoil activated video (RAV) is turned on, the rifle scope will record 8 seconds before the shot and 92 seconds after the shot.
- The video recording timer, in HH:MM:SS (hour, minute, second) format, will appear in the upper-right corner when RAV is recording.
- Long press the **Photo (P) Button** to stop and save the RAV recording at any time.
- When multiple shots are taken within the same 30-second period, only one video will be taken.
- When RAV recording is turned on, standard video recording is unavailable.

## Standby 📵

### Turn on automatic standby mode

1. Long press the **Menu (M) Button** to enter the main menu.
2. Rotate the **Control Turret** to select the standby 📵 menu item.



- Short press the **Menu** (M) **Button** to turn auto standby on / off  
When turned on, the ACE H50R will automatically enter standby after about 5 seconds.
- The standby icon and status, on or off, appear in the bottom status bar.
- Long press the **Menu** (M) **Button** to confirm the selection and return to the home screen.

#### NOTES:

- When auto standby mode is turned on:
  - The rifle scope will enter standby automatically when it is tilted up or down at an angle of more than 70° or left or right at an angle of more than 30°.
  - The rifle scope will not enter standby mode while it is in a level firing position.
  - Press any button to exit auto standby.
- When auto standby is turned off, the rifle scope will operate until the batteries run out.

## Microphone

### Turn the microphone on / off

- Long press the **Menu** (M) **Button** to enter the main menu.
- Rotate the **Control Turret** to select the microphone (M) menu item.
- Short press the **Menu** (M) **Button** to turn the microphone on / off. The microphone status, on (M) or off (M), appears in the top status bar.
- Long press the **Menu** (M) **Button** to return to the home screen.



## Pixel Defect Correction (+)

### Select and correct defective pixels

Defective pixels are pixels that do not change correctly compared to the other image pixels—they are either brighter or darker than surrounding pixels. The ACE H50R has a tool that corrects defective pixels on the sensor using its internal software.

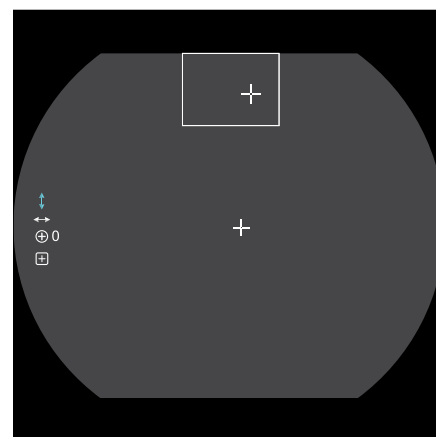

- Long press the **Menu** (M) **Button** to enter the main menu.
- Rotate the **Control Turret** to select the pixel defect correction (+) menu option.
- Short press the **Menu** (M) **Button** to enter the defective pixel correction interface.
- The interface has the following features:



- Cursor:** The pixel cursor appears in the center of the screen in place of the reticle. Move the cursor to the position of the defective pixel.
- PIP Window:** Shows a close-up view of the cursor location.
- X-Axis ↔ Icon:** Select to move the pixel cursor horizontally.
- Y-Axis ↑ ↓ Icon:** Select to move the pixel cursor vertically.
- Add + Icon:** Select to add a defective pixel to the "to be corrected" list. Shows the number of defective pixels in the list.
- Automatic Pixel Correction + Icon:** Select to automatically correct all defective pixels.





To auto-correct defective pixels:

1. Rotate the **Control Turret** to move to the automatic pixel correction  icon. The icon turns blue to mark the cursor location.
2. Short press the **Menu**  **Button** to correct all defective pixels automatically.







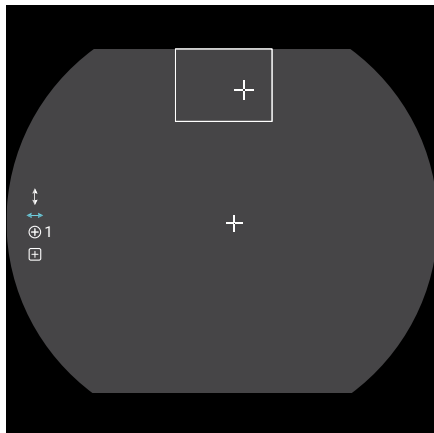

**NOTE:** If the algorithm fails to locate all defective pixels, it may be necessary to manually correct additional pixels.



To manually select and correct defective pixels:

3. Rotate the **Control Turret** to move between X and Y. The cursor location is marked by a blue icon.
4. Short press the **Menu**  **Button** to select the axis of movement, **X** or **Y**. The selected axis begins flashing.
5. Move the cursor along the selected axis to the location of the defective pixel:
  - a. Rotate the **Control Turret** counterclockwise to move in the positive direction: X= Right and Y= Up.
  - b. Rotate the **Control Turret** clockwise to move in the negative direction: X= Left and Y= Down.
  - c. Rotate one click to move the cursor in the corresponding direction by 1 pixel. One full rotation (20 clicks) is equivalent to 20 pixels.
6. Short press the **Menu**  **Button** to save the position for the selected axis and deselect it. When deselected, the axis will change from blue to white.
7. Repeat steps 3–6 to move the cursor along the second axis as needed.





8. With the pixel cursor position saved and marking the location of the defective pixel, use the **Control Turret** to move to the add icon , then short press the **Menu**  **Button** to add the pixel to the "to be corrected" list.
  - a.  0 will change to  1 to indicate that one pixel has been added to the correction list.
9. If the defective pixel has been added in error, short press the **Menu**  **Button** a second time from the same X/Y coordinates (do not move the cursor) to remove the pixel from the "to be corrected" list.
10. Repeat the above steps to add additional defective pixels, as needed.
11. When all defective pixels have been added to the list, long press the **Menu**  **Button** to confirm changes.
12. A popup window shows the message "Do you want to keep these settings?" and two options, Yes and No. Yes is selected by default.
13. Short press the **Menu**  **Button** to select **Yes** to correct the saved list of defective pixels and exit to the home screen.
14. Rotate the **Control Turret** to move to **No** and short press the **Menu**  **Button** to exit to the main menu without correcting any defective pixels.



**NOTE:** The PIP window will move to the bottom of the screen when the cursor moves into the top of the screen.

## Settings Menu

### Adjust the general settings

1. Long press the **Menu**  **Button** to enter the main menu.
2. Rotate the **Control Turret** to select the settings  menu item.
3. Short press the **Menu**  **Button** to enter the settings submenu.

## SETTINGS MENU > DATE

### Set the date

1. In the settings submenu, rotate the **Control Turret** to select the date  menu item.
2. Short press the **Menu  Button** to edit the date, displayed in YYYY.MM.DD format.. A blue arrow will appear above and below the year digit.
3. Rotate the **Control Turret** to select the correct value for each digit (year, month, and day).
4. Short press the **Menu  Button** to switch between digits. The two arrows move to indicate the selected digit.
5. Long press the **Menu  Button** to save the date and return to the home screen.



## SETTINGS MENU > TIME



### Set the time

1. In the settings submenu, rotate the **Control Turret** to select the time  menu item.
2. Short press the **Menu  Button** to edit the time, displayed in HH:MM, in 24-hour format. A blue arrow will appear above and below the hour digit.
3. Rotate the **Control Turret** to select the correct value for each digit (hour and minute).
4. Short press the **Menu  Button** to switch between digits. The two arrows move to indicate the selected digit.
5. Long press the **Menu  Button** to save the time and return to the home screen. The set time appears in the status bar.



## SETTINGS MENU > UNIT



### Set the units of measurement

1. In the settings submenu, rotate the **Control Turret** to select the unit  menu item.
2. Short press the **Menu  Button** to enter the submenu.
3. Rotate the **Control Turret** to move through the options, meters and yards.
4. Long press the **Menu  Button** to confirm the selection and return to the home screen.



## SETTINGS MENU > LANGUAGES

### Select the language

1. In the settings submenu, rotate the **Control Turret** to select the languages  menu item.
2. Short press the **Menu  Button** to enter the submenu.
3. Rotate the **Control Turret** to move through the language options.
4. Long press the **Menu  Button** to confirm the selection and return to the home screen.







## SETTINGS MENU > FIRMWARE UPDATE

### Update the firmware

Refer to the App for firmware update instructions as needed.

## SETTINGS MENU > FACTORY RESET

### Restore factory default settings

1. In the settings submenu, rotate the **Control Turret** to select the factory reset  menu item.
2. Short press the **Menu  Button** to enter the factory reset submenu.
3. Two options, No and Yes, appear; Yes will restore factory settings and No will cancel the operation.
4. Short press the **Menu  Button** to select **No** to confirm cancellation of the factory reset and return to the submenu; **OR**
5. Rotate the **Control Turret** to move to **Yes** and short press the **Menu  Button** to select it to confirm the factory reset. Factory settings will be restored and the ACE H50R will reboot automatically.





### FACTORY RESET NOTES:

- The screen will go dark and the factory restart will begin after a pause of about 10 seconds.
- A factory reset cannot be undone.
- The settings listed below will be reset to the factory defaults:
  - Color Palette: White Hot
  - Image Brightness: 5
  - Image Contrast: 5
  - Image Sharpness: 5
  - Digital Zoom: 1x
  - Ultra-Clear mode: Off
  - Wi-Fi: Off
  - Image Hue: C (Cool)
  - Calibration Mode: Manual
  - Microphone: Off
  - Language: English
  - Unit: M (Meters)
  - Wi-Fi Password: 12345678
  - Wi-Fi SSID: XXXXX\_YYYYYY

## SETTINGS MENU > INFO

### Show device information

1. In the settings submenu, rotate the **Control Turret** to select the info  menu item.
2. Short press the **Menu  Button** to display information about the ACE H50R: the model number, the GUI, SYS, boot, and FPGA, versions, the part and serial numbers, and the FCC ID.
3. Long press the **Menu  Button** to return to the home screen.



## 24. Basic Inspection

It is recommended to carry out a technical inspection before each use. Please check the following:

- The imager appearance: there should be no cracks in the body or visible damage.
- The condition of the objective lens and eyepiece: there should be no cracks, greasy spots, dirt, or other deposits on the lens.
- The rechargeable battery should be fully charged.
- The control buttons should be in working order.

## 25. Basic Maintenance

Always replace the objective lens cap (2) after use to avoid damaging or scratching the lens. Never touch the lens directly; oil from your skin can damage the lens coating and surface.

Basic maintenance should be carried out at least twice a year and includes the following steps:

- Wipe the surface of the external metal and plastic components with a clean, dry cotton cloth. Do not use chemical, corrosive, or abrasive cleaners. Canned air may also be used to clean the external components.
- Clean the electric contacts and battery slots on the imager using a non-greasy organic solvent.
- Check the lens and eyepiece. Remove dirt or sand from the optics as needed; a non-contact cleaning method is preferred.

- Cleaning the exterior of the lens should only be done with the included microfiber lens cloth or a similar product. Only clean the lens when it is visibly soiled. Frequent wiping or cleaning can degrade the anti-reflective lens coating.

## 26. Warranty

At iRayUSA we're first and foremost hunters and users of our products and we understand that failure isn't an option. We also understand that having to wait extended periods for repair isn't something that a customer should have to put up with when something does go wrong. During your published warranty period, iRayUSA will repair or replace, at its discretion, any optic that becomes defective during normal use. Additionally, if we cannot fix your optic in less than one week, we will offer to replace it with a replacement product in like or better condition. If you would rather wait for your specific optic to be repaired, we can handle that too.

We know you've never seen this from a thermal manufacturer and neither have we; that's why we started iRayUSA.

Our warranty follows the product and is not tied to the original owner. The warranty period is tied to the date of sale to the dealer. This warranty only covers normal use and does not cover cosmetic damage, normal wear, intentional damage, theft, loss, any act of God, or a condition caused by use other than intended. Any product that is modified, opened, or tampered with will void any warranty coverage. Any serial number damage or alteration on the product will be considered a modification. Be sure to register your ACE H50R thermal imaging rangefinder at [irayusa.com/register](http://irayusa.com/register).

To return a product for repair:

1. Go to [irayusa.com/warranty](http://irayusa.com/warranty) and click the **Request an RMA button** to request an RMA number. Returns will not be accepted without an RMA.
2. The customer is responsible for shipping the product to iRayUSA, per the instructions included with the RMA. iRayUSA will return the product at no cost.

### WARRANTY NOTES:

- The one-week timeline starts from the time of receipt of the product at iRayUSA.
- iRayUSA is not liable for any damages or loss incurred when shipping to iRayUSA.
- This warranty gives you specific legal rights, and you may also have other rights which vary from state to state.

Please give us a call at **800-769-7125**, visit [irayusa.com/warranty](http://irayusa.com/warranty), or email [info@irayusa.com](mailto:info@irayusa.com) with any questions.

## 27. FCC Statement

### FCC ID: 2BHFB-ACE-00

This device complies with part 15 of the FCC Rules. Operation is subject to the following two conditions: (1) This device may not cause harmful interference, and (2) this device must accept any interference received, including interference that may cause undesired operation.

**CAUTION:** Changes or modifications not expressly approved by IRayUSA could void the user's authority to operate the equipment.

**NOTE:** This equipment has been tested and found to comply with the limits for a Class B digital device, pursuant to part 15 of the FCC Rules. These limits are designed to provide reasonable protection against harmful interference in a residential installation. This equipment generates, uses and can radiate radio frequency energy and, if not installed and used in accordance with the instructions, may cause harmful interference to radio communications. However, there is no guarantee that interference will not occur in a particular installation. If this equipment does cause harmful interference to radio or television reception, which can be determined by turning the equipment off and on, the user is encouraged to try to correct the interference by one or more of the following measures:

- Reorient or relocate the receiving antenna.
- Increase the separation between the equipment and receiver.
- Connect the equipment into an outlet on a circuit different from that to which the receiver is connected.
- Consult the dealer or an experienced radio/TV technician for help.

This device was tested for typical body-supported operations and use. To comply with RF exposure requirements, a minimum separation distance of 0.5cm must be maintained between the user's body and the handset, including the antenna. Third-party belt-clips, holsters, and similar accessories used by this device should not contain any metallic components. Body accessories that do not meet these requirements may not comply with RF exposure requirements and should be avoided. Use only the supplied or an approved antenna.

## 28. General Troubleshooting

The troubleshooting table on the next page lists issues that may occur when operating the ACE H50R. Carry out the recommended troubleshooting steps in the order shown in the table. Please contact iRayUSA at 800-769-7125 or [irayusa.com/support](http://irayusa.com/support) or an authorized vendor for assistance before attempting to perform any modifications or repairs beyond the scope of the troubleshooting procedures in this manual. Unauthorized repairs or modifications will void your warranty.

ISSUE	POSSIBLE CAUSES
The ACE H50R will not turn on.	The battery is very low or has completely discharged.
The ACE H50R can not connect to a computer or external power supply.	External power supply has completely discharged.
	Computer is turned off.
	USB-C cable is damaged.
The ACE H50R can not connect to the mobile device (smartphone or tablet).	Wi-Fi is not turned on.
	Wrong Wi-Fi password entered.
	Too many Wi-Fi signals nearby, which may cause interference.
Wi-Fi signal is lost or interrupted.	The device is out of range of a strong Wi-Fi signal, or there are obstacles (such as concrete walls) between the device and the signal.
The image is blurry, the background is uneven, or vertical lines or artifacts are present.	Non-uniformity correction is required.
The image is too dark.	Image brightness level is too low.
The GUI is clear, but the image is blurry.	The lens is not focused.
	There is dust or ice on the interior or exterior optical surfaces of the lens.
	There is condensation on the interior or exterior optical surfaces of the lens.
The image of the object being observed is missing.	Looking through glass.
The ACE H50R will not focus.	Image settings are not optimal for the current environmental conditions or the object being observed.
Image quality is too low or the detection range is reduced.	These issues may occur due to the weather conditions, such as snow, rain, humidity, and fog.
When the ACE H50R is used in low-temperature conditions, the image quality of the surroundings is worse than in warm-temperature conditions.	Environmental conditions.

TROUBLESHOOTING STEPS
Charge the battery.
Check the external power supply and charge it if necessary.
Power on the computer.
Replace the cable.
Turn on the Wi-Fi in the main menu. See <b>Main Menu &gt; Wi-Fi</b> on page 36.
On the mobile device, go to <b>Settings &gt; Wi-Fi</b> and enter the correct password. The default password is 12345678. See <b>Main Menu &gt; Wi-Fi</b> on page 36.
Move the ACE H50R and mobile device to an area with no or fewer Wi-Fi signals.
<ul style="list-style-type: none"> <li>Try again when the Wi-Fi signal is stable.</li> <li>Move the ACE H50R closer to the Wi-Fi signal.</li> </ul>
Perform a non-uniformity correction. See <b>Non-uniformity Correction</b> on page 22 and <b>Using the Quick Menu</b> on page 19.
Adjust the image brightness in the quick menu. See <b>Using the Quick Menu</b> on page 19.
<ul style="list-style-type: none"> <li>Adjust the focus on the target by rotating the objective focus ring (3).</li> <li>Adjust the image sharpness in the quick menu. See <b>Using the Quick Menu</b> on page 19.</li> </ul>
<ul style="list-style-type: none"> <li>Wipe the external optical surface with the included microfiber lens cloth.</li> </ul>
<ul style="list-style-type: none"> <li>Wipe the external optical surface with the included microfiber lens cloth.</li> <li>Allow the ACE H50R to dry by leaving it in a warm, dry environment for at least 4 hours.</li> </ul>
Remove any glass windows from the field of view.
<ul style="list-style-type: none"> <li>Check the external surface of the objective lens and eyepiece and, where necessary, wipe away any dust, condensation, frost, etc.</li> <li>In cold weather, you can use special anti-fogging coatings, such as those made for corrective glasses.</li> <li>Adjust the focus on the target by rotating the objective focus ring (3).</li> <li>Adjust the image sharpness in the quick menu. See <b>Using the Quick Menu</b> on page 19.</li> <li>Adjust the image and device settings. See <b>Quick Start Guide</b> on page 8.</li> <li>Turn on Ultra-Clear mode. See <b>Main Menu &gt; Ultra-Clear</b> on page 29.</li> </ul>
Turn on Ultra-Clear mode. See <b>Main Menu &gt; Ultra-Clear</b> on page 29.
In warm-temperature conditions, objects being observed (surroundings and background) heat up differently because of thermal conductivity, thereby generating a high-temperature contrast. Accordingly, image quality produced by the imager will be higher. In low-temperature conditions, the background will cool down to roughly the same temperature, and thus the temperature contrast is substantially reduced and image detail can go down as there is less contrast in the scene. This is a normal function of a thermal imager and is no indicator of actual detector performance.





2601 State Hwy 121, Bldg 3, Ste 306  
Lewisville, TX 75056  
800-769-7125 | 682-499-0047  
[info@irayusa.com](mailto:info@irayusa.com)